

3

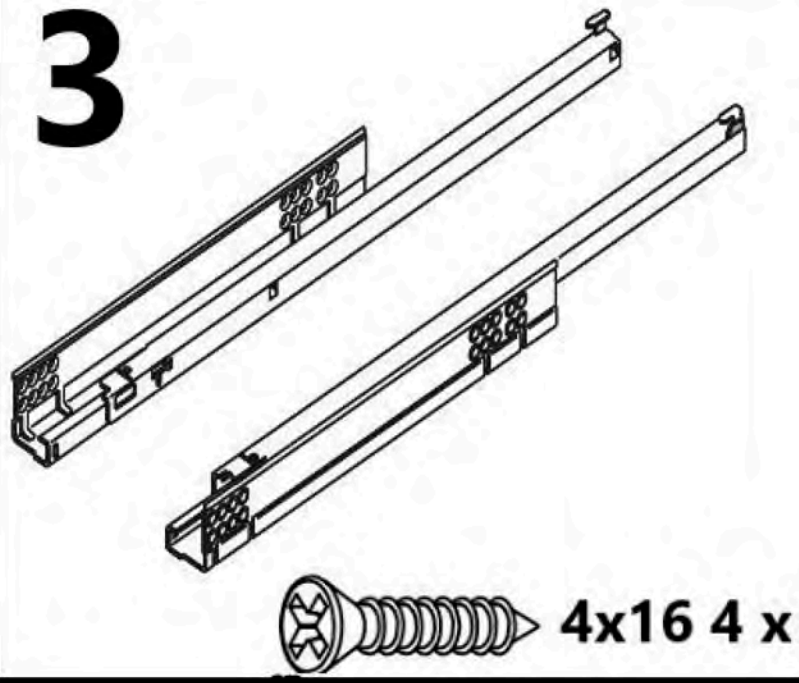

3303-92

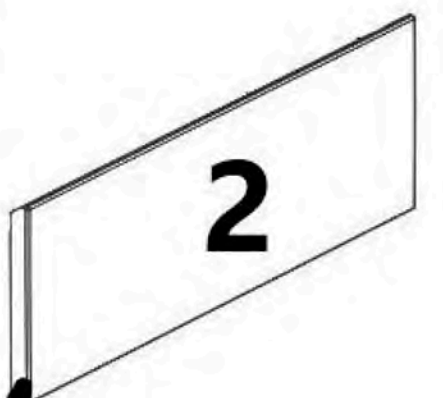

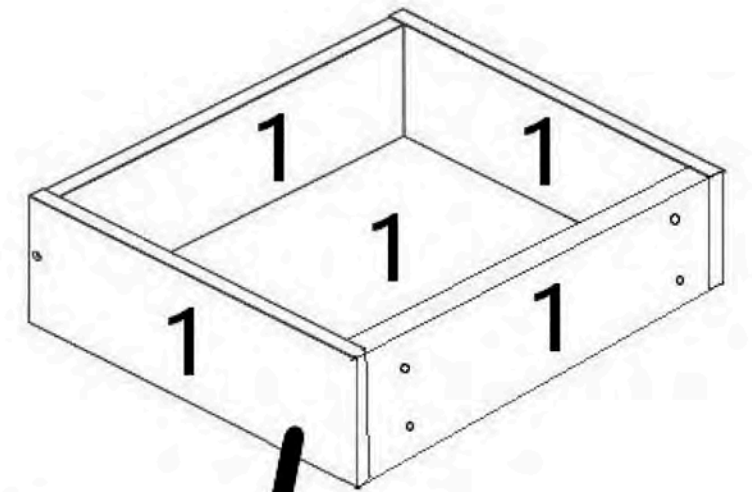
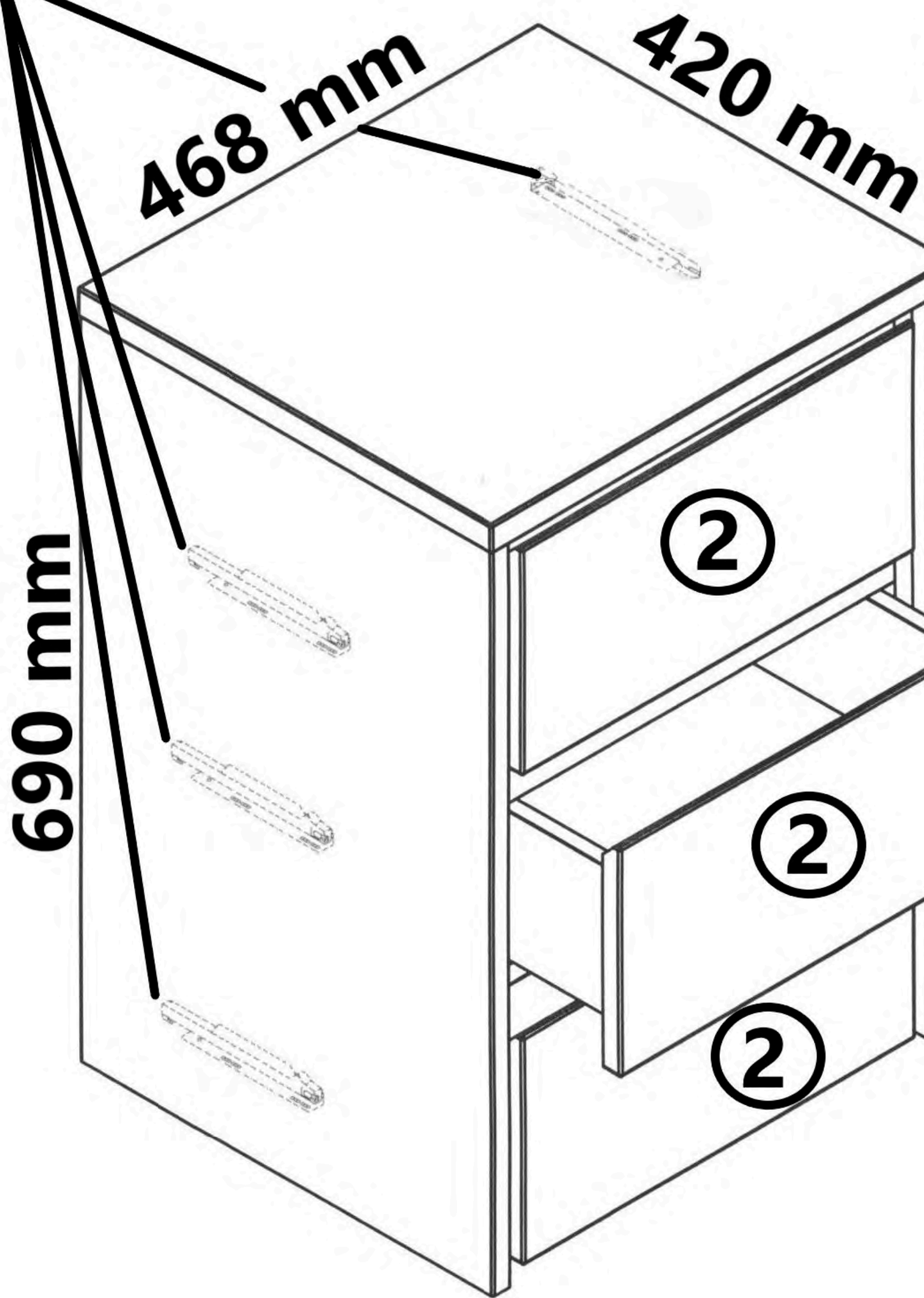
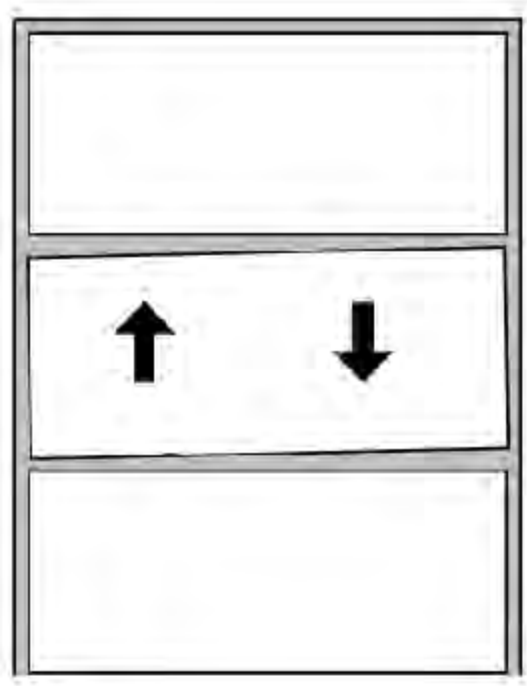

+ - 2 mm

